



KAOKO™ THROTTLE STABILIZER KITS: HND330

RSA Registered Designs
No. A2007/00202 No. A2007/00205
No. A2007/00203 No. A2007/00206
No. A2007/00204 No. A2007/00207

Patents
"U.S. Pat. No. US D593,462 S"
"U.S. Pat. No. US D593,463 S"
"U.S. Pat. No. US D593,464 S"

For Models **HONDA**
NC750X (2018-)
With OEM heated grips
With OEM hand guards or Barkbusters

Items Included in your kit
Kaoko bar-end weight • Friction Nut • TH-TWD103 Thrust Washer • M8x80 Bolt
M8 Steel spacer • 2mm Allen Key • Fitting Instructions

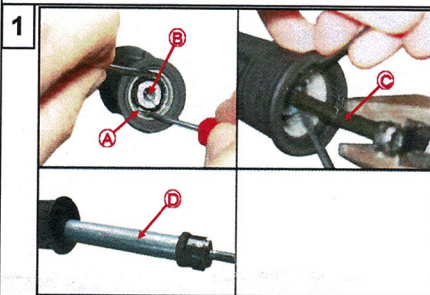

- A**— Two spring tabs
- B**— Handlebar insert
- C**— Bar-end retaining screw
- D**— Handlebar Insert removed

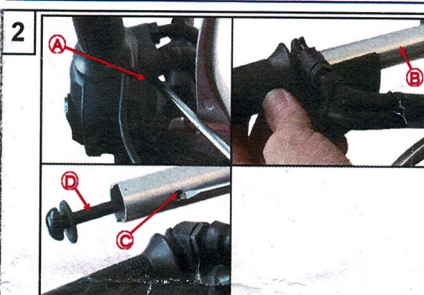

- A**— Clamp Screws
- B**— Handlebar Tube
- C**— Location Pins
- D**— Central Retaining Bolt

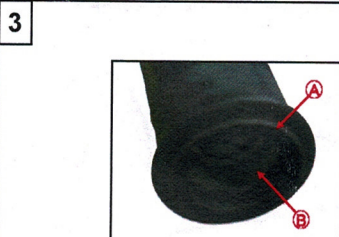

- A**— Plastic Thrust Washer
- B**— Throttle Sleeve

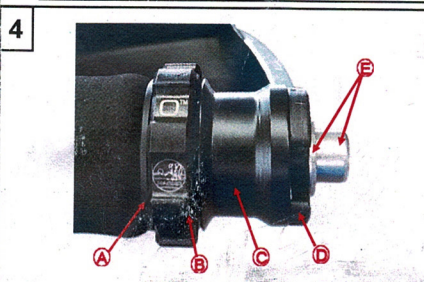

- A**— Plastic Thrust Washer
- B**— Friction Nut & Grub Screw
- C**— Kaoko bar-end weight
- D**— Hand guard
- E**— Central retaining bolt with M8 washer

DISCLAIMER: NO RESPONSIBILITY ACCEPTED FOR NON-ADHERENCE TO THESE INSTRUCTIONS

KAOKO™ Safety Warning:

The KAOKO™ Throttle Stabilizer is an aftermarket accessory. Any misunderstood, abused or incorrectly installed motorcycle accessory is a safety hazard that could cause injury or death. It's the rider's responsibility to understand the operation and purpose for which the KAOKO™ Throttle Stabilizer is designed, namely, for cruising, only when safe to do so. At all other times the control should be disengaged. The KAOKO™ Throttle Stabilizers are to be used only by experienced and responsible riders. See reverse of page for full indemnity.
Note: An adjustment to throttle assembly position may be necessary to suit KAOKO™ Throttle Stabilizers. The throttle assembly position on aftermarket bars, and some OEM bars, is adjustable. The assembly can marginally be re-positioned along the handle bars slightly loosening the throttle assembly clamp screws, and then sliding the throttle assembly along the handle bars (left or right). Once done, firmly tighten the clamp screws to OEM torque specifications. This adjustment is generally not necessary.

Fitting Instructions

Step 1

Step A (recommended): **Picture 1**—Remove the Throttle side bar weight. Using two small screw drivers, prize the two spring tabs towards each other and simultaneously pull out the handle bar insert. The spring tab is located deep inside the handle bar. Discard the handle bar insert.

Step B (optional—if required): **Picture 2**—Remove the Throttle side bar weight. Loosen throttle assembly clamp screws and slide the throttle assembly off the handle bar tubes. Refit the central retaining bolt to the handle bar insert, depress the handle bar insert location pins, and remove the entire insert from the handle.

Step 2

Place the plastic thrust washer into end of the throttle sleeve that the spigot of the thrust washer must thrust upon the plastic throttle sleeve. (see picture 3).
To enable improved functionality, it is recommended (not essential) to apply very light smear of Automotive grease or Petroleum jelly to the friction face of the thrust washer (See Figure 3 at the back of the page)

Step 3

When installing with OEM handguards: Place hand guard onto the end of the Kaoko bar-end weight as shown in picture 4 and secure the entire assembly using the M8x80 bolt and M8 Steel spacer as shown in picture 4.

When installing with Barkbusters: Place the Barkbuster hand guard bracket onto the end of the Kaoko bar-end weight and secure the entire assembly using only the M8x80 bolt provided in the Kaoko kit— **the M8 steel spacer is not to be used with Barkbusters hand guards!**

Step 4

Carefully set rotational resistance of the friction nut by tightening/loosening the grub screw by small adjustments using the 2mm allen key provided in the Kaoko Kit. Take care not to over tighten risking damage to threads. The nut should have fairly firm rotational resistance. See under **Maintenance** below.

Operating Instructions

The Friction Nut has a **left hand thread**. In readiness for engagement, the Friction Nut must be adjusted so that it makes light contact against the thrust washer.

To Engage: While rolling on the throttle, the Friction Nut can be gripped between the small finger and palm of hand. This action tightens the nut and provides sufficient friction to set the throttle to the desired opening. *(The friction is such that the rider may still open and close the throttle. The throttle simply has a slight rotational stiffness.)*

To Disengage: While rolling off the throttle, grip the Friction Nut between small finger and palm of hand.

VERY IMPORTANT!! The throttle should open and snap closed freely when correctly disengaged.

Note: The Grub Screw is set to provide the necessary resistance on thread of friction nut. This may be adjusted periodically to take up wear.

Maintenance: Remove kit annually. Unscrew Friction Nut and brush clean threads with a mild soap. Apply petroleum jelly to threads and assemble. Adjust grub screw to desired operating resistance. *(O-Ring cushion: 19.6mm I.D. x 2.4mm section — if replacement is required)*

Figure 1: Typical KAOKO Throttle Stabilizer Components

rev: 03/03/2017

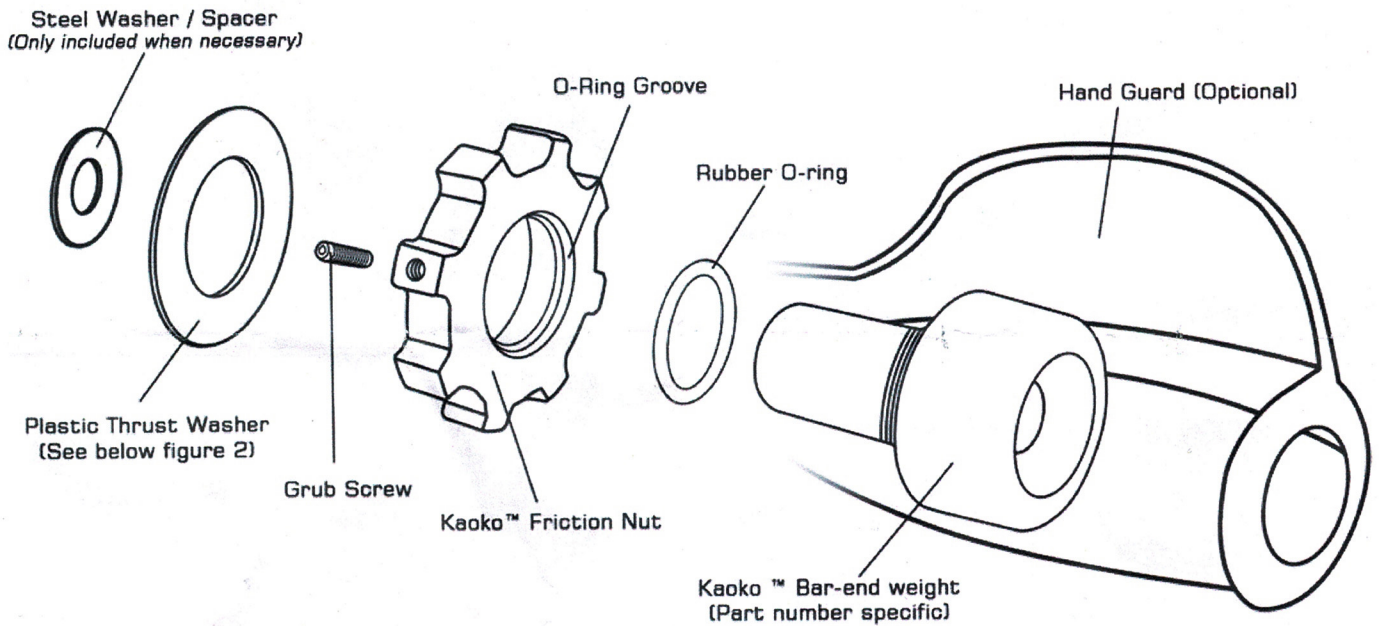

Figure 2: Thrust Washer Final Fitment

Note: The KAOKO™ Thrust Washer (ref: figure 1) must thrust against the plastic throttle sleeve (tube) indicated below in figure 2.

The KAOKO™ Thrust Washer must not thrust against the rubber throttle grip. Refer detailed instructions on reverse.

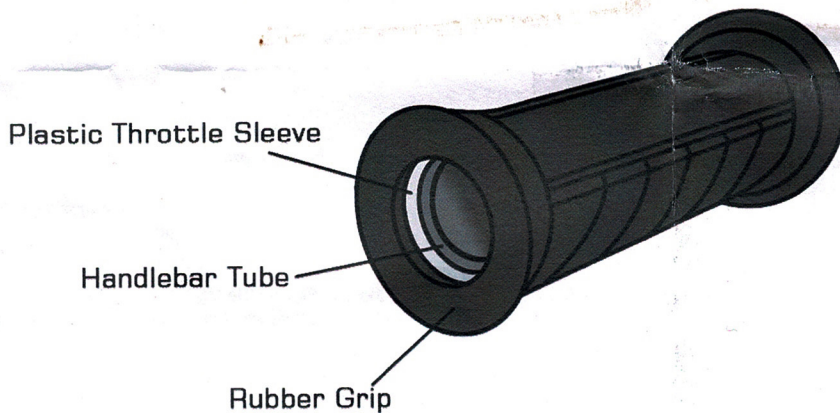
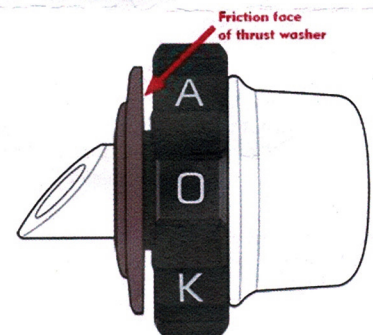

Figure 3



KAOKO™ ACCESSORIES AND PRODUCTS

Express Disclaimer, Exclusion of Liability, Indemnity and Safety Warning:

1. The accessories and products supplied by KAOKO™ are aftermarket accessories and products.
2. The use and employment of such accessories and products is at the sole risk and discretion of the user.
3. The user of such accessories and products further indemnifies KAOKO™ and its representatives against all claims and losses arising (including personal injuries, death, damage to property and any other losses) and involving such accessories and products.
4. KAOKO™ provides no warranty on accessories and products that it produces and distributes and does not aver that these accessories and products are fit for the purposes for which same are manufactured and intended.
5. KAOKO™ assumes no responsibility for and liability regarding any and all defects, deficiencies or otherwise in and attributed to its motor accessories and products.
6. KAOKO™ further assumes no responsibility for and liability regarding any prospective losses and claims for damages; be same actual, consequential or contingent and which in any way are associated with its motor accessories and products. In circumstances where accessories and products supplied are found to be of defective manufacture, KAOKO™ reserves its rights to replace such defective accessories and products, alternatively; effect a financial refund equivalent to the purchase price of such accessories and products as at the date of placement of order.
7. The application and affixing of KAOKO™ accessories and products to vehicles may necessitate or result in modifications being undertaken and this may result in manufacturer or otherwise warranties provided on such vehicles being affected and for that matter voided. In circumstances where the above occurs, KAOKO™ expressly denies being accountable regarding any liability and losses ensuing.
8. The application and affixing of KAOKO™ accessories and products may further result in usual vehicle operations and safety features being modified, overrode and for that matter discarded.
9. KAOKO™ accessories and products ought to be used by experienced and responsible riders only. The onus rests on the user of such KAOKO™ accessories and products to become properly familiarised with and understand the nature, operation and scope of the above accessories and products and further ensure that same are correctly affixed and used at all times and further not abused.
10. **Misapplication and abuse of such accessories and products can endanger the user and result in injury or death and further constitute safety hazards.**
11. The affixing and usage advices provided by KAOKO™ are for guidance purposes only and do not constitute specific fitment instructions. The onus rests on the user to ascertain and ensure proper and professional affixing and fitting to vehicles of the accessories and products and in seeking suitably qualified assistance in dealing with the above.
12. Prior to resorting to using KAOKO™ accessories and products, it is recommended that the user seek independent advice regarding the integrity and suitability of above accessories and products and in fulfilling the user's needs.
13. KAOKO™ accessories and products should only be fitted to new motorcycles and those that are in original condition, having not been involved in any accidents, being dropped, damaged or the subject of repair. Where KAOKO™ accessories and products are fitted to motorcycles not in original condition there is the risk that the operation of KAOKO™ accessories and products will be compromised and damaged. **In all of the above events, KAOKO™ does not accept liability**